

FASTENER IDENTIFICATION GUIDE

November 23, 2022



Illinois Department of Transportation

Revision Information Log
 Guide for Approved Fasteners
 November 23, 2022



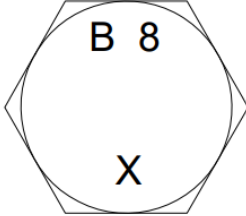
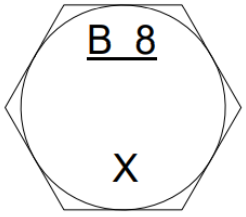
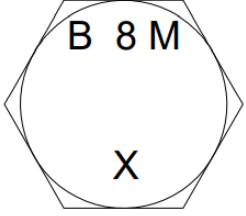
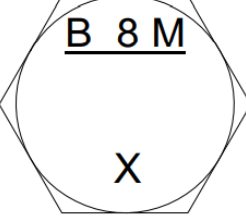
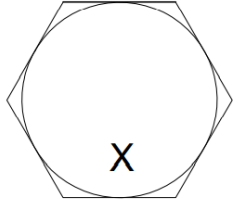

Effective Date:	Description of Change:	Authorized By:
03/21/08	Date added to guide cover	Ray Rowden
03/21/08	Revision Information Log added	Ray Rowden
05/15/08	Dyson Corporation—New Nut Drawings	Ray Rowden
05/16/08	Andre Corporation—New Washer Drawings	Ray Rowden
05/23/08	Technical Stamping Incorporated—New Washer (TY-III)	Ray Rowden
10/03/08	St. Louis Screw & Bolt—New Bolt Drawings	Ray Rowden
10/03/08	Decker Manufacturing Corp.—New Nut Drawings	Ray Rowden
10/03/08	Vegas Fastener Manufacturing—New Bolt Drawings	Ray Rowden
10/03/08	Prestige Stamping—New Washer Drawings	Ray Rowden
10/03/08	Mid-West Fabricating—New Bolt Drawings	Ray Rowden
06/21/22	Cox Industries – New Stud Shear Connector Drawings	Luke Wylde and Spencer Gibbs
07/28/22	Update of the 2008 Fastener Ident. Guide: <ul style="list-style-type: none"> • Altered fonts, added tables and guides to hardware figures • Updated previous comments and notes for individual figures and codes • Updated Bolts-Studs identification instructions: A325 and A490 to reference the combined standard ASTM F3125 	Luke Wylde and Spencer Gibbs
08/18/22	Created a new page differing the Identification Guide from the QPL and assuring producers know foreign steels may be applicable to some products	Luke Wylde and Spencer Gibbs
08/29/22	Removed D-flagged material codes	Luke Wylde and Spencer Gibbs
09/12/22	Updated Lake Erie Screw Corp. to Fontana Fasteners	Luke Wylde
11/23/22	St. Louis Screw & Bolt – New Bolt Drawings for the following: <ul style="list-style-type: none"> • ASTM F3125 A325 TY-I/-III • ASTM A449 TY-I/-III • ASTM F3125 A490 TY-I/-III 	Spencer Gibbs
11/23/22	Fontana Fasteners – New Bolt, Washer, and Nut Drawings for the following: <ul style="list-style-type: none"> • ASTM F3125 A325 TY-I/-III • ASTM F3125 A490 TY-I/-III • ASTM A563 GR C/D/DH3 • ASTM A194 GR 2H • ASTM F436 CS 	Spencer Gibbs

Please note that the Fastener Identification Guide does not act in place of IDOT's Qualified Products List. In addition, Producer's markings listed in this Identification Guide may be made from Foreign Steel. Please check the material certification for Domestic Steel Compliance.

Instructions for identification for Bolts and Studs

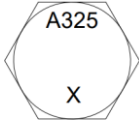
Specification and Material Codes	Grade Marking	Required Markings
ASTM A193 Grade B8 Class I Regular Series Heavy Series 67608		Symbol for identification of grade, i.e., "B8", applied to head. Manufacturer's identification mark, e.g., "X" (on head of bolts and screws and on one end of studs and studs-bolts).
ASTM A193 Grade B8 Class II (Strain Hardened Material) Regular Series and Heavy Series		Symbol for identification of grade, i.e., "B8", applied to head. Line stamped under "B8". Manufacturer's identification mark, e.g., "X" (on head of bolts and screws and on one end of studs and stud bolts).
ASTM A193 Grade B8M Class I Regular Series and Heavy Series		Symbol for identification of grade, i.e., "B8M", applied to head. Manufacturer's identification mark, e.g., "X" (on head of bolts and screws and on one end of studs and stud bolts).
ASTM A193 Grade B8M Class II (Strain Hardened Material) Regular Series and Heavy Series		Symbol for identification of grade, i.e., "B8M", applied to head. Line stamped under "B8M". Manufacturer's identification mark, e.g., "X" (on head of bolts and screws and on one end of studs and stud bolts).
ASTM A 307* Grade A Grade B Regular series and Heavy Series A or B 67614 Galv. A or B 67614 Square head: (same as above) Round Slotted: N/A Galv. 67627 Round Slotted Countersunk: (same as round slotted)		Manufacturer's identification mark, e.g., "X", applied to head (raised or depressed at option of manufacturer). *When ASTM A 307 bolts are submitted for testing and the grade is not known, it is suggested that the material code for Grade A or B is used.

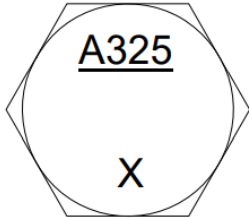
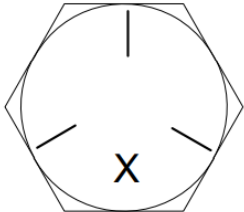
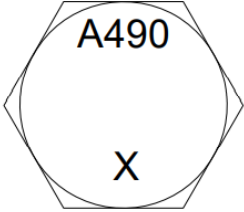
Instructions for identification for Bolts and Studs

Specification and Material Codes	Grade Marking	Required Markings
<p>ASTM F3125 (A325) Type 1 Heavy Series</p> <p>65501 Galv. 67616 Dual Ring: (same as above) Round Countersunk: (same as above) Torque: N/A</p>	 	<p>Symbol for identification of grade, i.e., "A325", applied to head.</p> <p>Manufacturer's identification mark, e.g., "X", applied to head (raised or depressed at option of manufacturer).</p> <p>Three radial lines applied to head 120 degrees apart (at option of the manufacturer).</p>
<p>ASTM F3125 (A325) Type 3 Heavy Series</p> <p>65503 Torque: (same as above) Round Countersunk: (same as above)</p>		<p>Symbol for identification of grade, i.e., "325", applied to head. Line stamped under "A325".</p> <p>Manufacturer's identification mark, e.g., "X", Applied to head (raised or depressed at option of the manufacturer).</p> <p>Other distinguishing marks applied to head indicating bolt is atmospheric corrosion resistant and of a weathering type (at option of manufacturer)</p>
<p>ASTM A 449 Regular Series</p> <p>67617M Galv. 67618M</p>		<p>Manufacturer's identification mark, e.g., "X", Applied to head (raised or depressed at option of the manufacturer).</p> <p>Three radial lines applied to head 120 degrees apart.</p>
<p>ASTM F3125 (A490) Type 1 Heavy Series</p> <p>67619</p>		<p>Symbol for identification of grade, i.e., "490", applied to head.</p> <p>Manufacturer's identification mark, e.g., "X", applied to head (raised or depressed at option of manufacturer).</p>
<p>ASTM F3125 (A490) Type 2 Heavy Series</p>		<p>Symbol for identification of grade, i.e., "A490", applied to head.</p> <p>Manufacturer's identification mark, e.g., "X", applied to head (raised or depressed at option of manufacturer).</p> <p>Six radial lines applied to head 30 degrees apart.</p>

Instructions for identification for Bolts and Studs

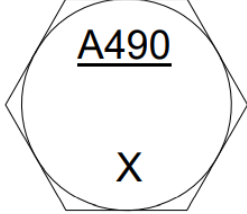
Specification and Material Codes	Grade Marking	Required Markings
ASTM F3125 (A490) Type 3 Heavy Series		Symbol for identification of grade, i.e., "490", applied to head. Line Stamped under "A 490". Manufacturer's identification mark, e.g., "X", Applied to head (raised or depressed at option of the manufacturer).

Typical:

Hex Galv.— N/A
Hex Alum.— N/A

Round Galv.—67631
Round Alum.— N/A

Stainless Steel—67604
Shear Connector Stud--65801

Fasteners—Bolts

P/S No.	P/S Name	City	State	Date	Status
4505-01	A&G Engineering Co.	Anaheim	CA	12/08/98	APPR

Mat. Code	Mat. Type	Figure
67612	A307 Gr A/B Black	A
67614	A307 Gr A/B Galv.	A
65501	A325 TY-I Black	B
67616	A325 TY-I Galv.	B
67619	A490 TY-I Black	C

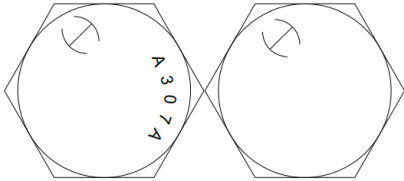
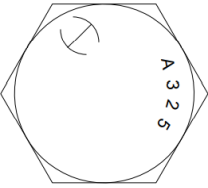
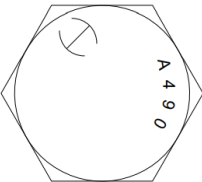
A	
B	
C	

P/S No.	P/S Name	City	State	Date	Status
5760-01	All Pro Fastener, Inc.	Arlington	TX	10/18/01	APPR

Mat. Code	Mat. Type	Figure
67671	A394 TY-O Galv.	A

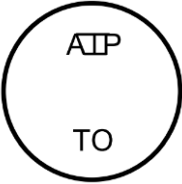
A	
---	---

P/S No.	P/S Name	City	State	Date	Status
4399-01	Alpine Bolt & Forming	Marengo	IL	12/08/98	APPR

Mat. Code	Mat. Type	Figure
67612	A307 Gr A/B Black	A
67614	A307 Gr A/B Galv.	A
67631	A307 Rnd. Head Galv.	B

A	<p>The diagram shows four hexagonal bolt heads arranged horizontally. Each hexagon contains a circle representing the bolt's cross-section. The labels are: 'AB' (circle centered), 'A' (circle centered), 'A B' (circle centered), and 'RSI' (circle centered).</p>
B	<p>The diagram shows four circular bolt heads arranged horizontally. Each circle contains a smaller circle representing the bolt's cross-section. The labels are: 'AB' (small circle centered), 'A' (small circle centered), 'A B' (small circle centered), and 'RSI' (small circle centered).</p>

P/S No.	P/S Name	City	State	Date	Status
4756-01	Auto Bolt & Nut	Cleveland	OH	12/08/98	APPR

Mat. Code	Mat. Type	Figure
67612	A307 Gr A/B Black	A
67614	A307 Gr A/B Galv.	A
67612	A307 Gr B Black	B
67614	A307 Gr B Galv.	B
65501	A325 TY-I Black	C
67616	A325 TY-I Galv.	C
67617	A449 Black	D
67618	A449 Galv.	D
67619	A490 TY-I Black	E

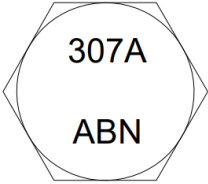
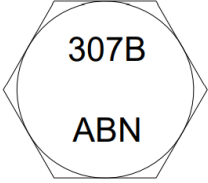
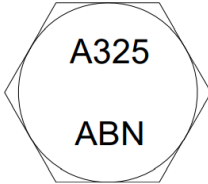
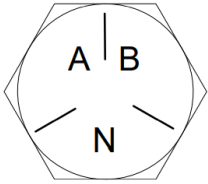
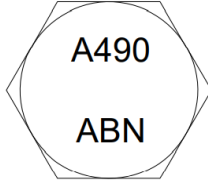
A	
B	
C	
D	
E	

P/S No.	P/S Name	City	State	Date	Status
224-02	BBC Fasteners	Alsip	IL	12/08/98	APPR

Mat. Code	Mat. Type	Figure
N/A	A307 Rnd. Slot Black	A
67627	A307 Rnd. Slot Cnt. Galv.	A
67614	A307 Sqr. Head Black	B
67614	A307 Sqr. Head Galv.	B
65501	A325 TY-I Black	C
67616	A325 TY-I Galv.	C
65503	A325 TY-III Black	D
67619	A490 TY-I Black	E
67673	A490 TY-III Black	F

A	
B	
C	
D	
E	

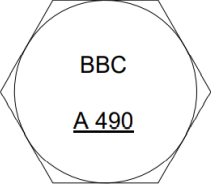
F	 <p data-bbox="834 268 889 296">BBC</p> <p data-bbox="829 323 894 350"><u>A 490</u></p>
---	--

P/S No.	P/S Name	City	State	Date	Status
4721-01	Birmingham Fastener Supply	Birmingham	AL	12/08/98	APPR

Mat. Code	Mat. Type	Figure
67612	A307 Gr A/B Black	A
67614	A307 Gr A/B Galv.	A
67612	A307 Gr B Black	B
67614	A307 Gr B Galv.	B

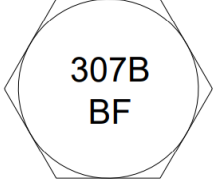
A	
B	

P/S No.	P/S Name	City	State	Date	Status
309-01	Cardinal Fastener & Specialty	Bedford Heights	OH	6/13/00	APPR

Mat. Code	Mat. Type	Figure
65501	A325 TY-I Black	A
67616	A325 TY-I Galv.	A
67668	A354 Gr. BD (Grade 8) Galv.	B
67619	A490 TY-I Black	C

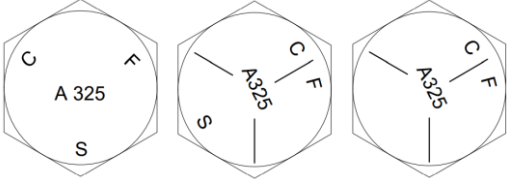
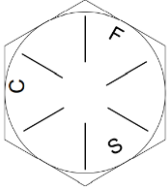
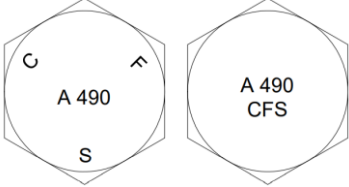
A	
B	
C	

P/S No.	P/S Name	City	State	Date	Status
6105-01	Chicago Fastener Manufacturing	Mokena	IL	5/03/06	APPR

Mat. Code	Mat. Type	Figure
65501	A325 TY-I Black	A
67616	A325 TY-I Galv.	A

A	
---	--

P/S No.	P/S Name	City	State	Date	Status
4494-01	Cold Heading Co.	Detroit	MI	12/08/98	APPR

Mat. Code	Mat. Type	Figure
67617	A449 Black	A
67618	A449 Galv.	A

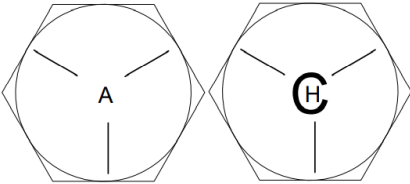
A	
---	--

P/S No.	P/S Name	City	State	Date	Status
5675-01	Copper State Bolt & Nut	Phoenix	AZ	1/19/00	APPR

Mat. Code	Mat. Type	Figure
65501	A325 TY-I Black	A
67616	A325 TY-I Galv.	A

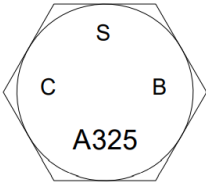
A	
---	---

P/S No.	P/S Name	City	State	Date	Status
4548-01	Custom Bolt	Phoenix	AZ	12/08/98	APPR

Mat. Code	Mat. Type	Figure
67612	A307 Gr A/B Black	A
67614	A307 Gr A/B Galv.	A
67612	A307 Gr B Black	B
67614	A307 Gr B Galv.	B
65501	A325 TY-I Black	C
67616	A325 TY-I Galv.	C
67617	A449 Black	D
67618	A449 Galv.	D
67619	A490 TY-I Black	E

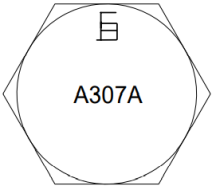
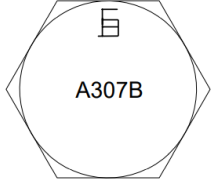
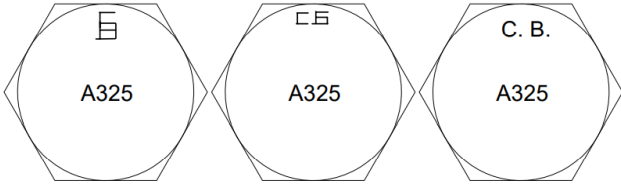
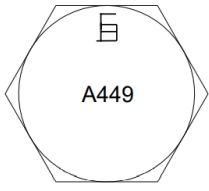
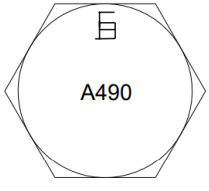
A	
B	
C	
D	
E	

P/S No.	P/S Name	City	State	Date	Status
4686-01	Del-Val Fastener Mfg. Co., Inc.	Ivyland	PA	12/08/98	APPR

Mat. Code	Mat. Type	Figure
67608	A193 Gr B8 CL-I SS	A
N/A	A193 Gr B8 CL-I SS STD	B
N/A	A193 Gr B8 CL-II SS	C
N/A	A193 Gr B8 CL-II SS STD	D
N/A	A193 Gr B8M CL-I SS	E
N/A	A193 Gr B8M CL-II SS	F

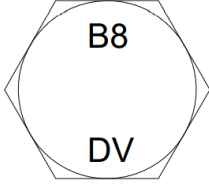
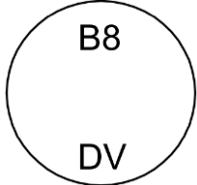
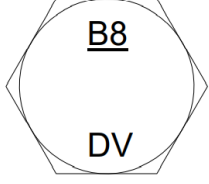
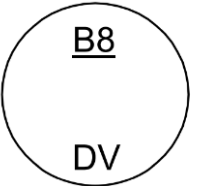
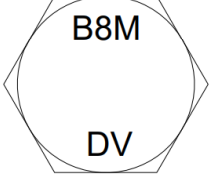
A	
B	
C	
D	
E	

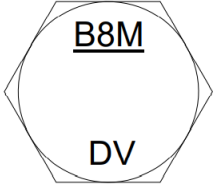
F	
---	---





P/S No.	P/S Name	City	State	Date	Status
1100-01	Fontana Fasteners	Frankfort	IN	12/08/98	APPR

Mat. Code	Mat. Type	Figure
65501	A325 TY-I Black	A (Updated 11/23/22)
67616	A325 TY-I Galv.	A (Updated 11/23/22)
65503	A325 TY-III Black	B (Updated 11/23/22)
67617	A449 Black	C
67618	A449 Galv.	C
67619	A490 TY-I Black	D (Updated 11/23/22)
67619	A490 TY-III Black	E (Added 11/23/22)

A	
B	
C	
D	
E	

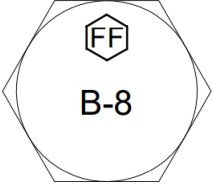
P/S No.	P/S Name	City	State	Date	Status
3709-01	Formed Fasteners	Bridgeview	IL	12/08/98	APPR

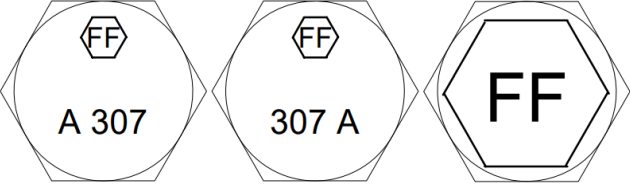
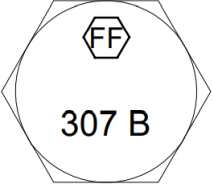
Mat. Code	Mat. Type	Figure
67608	A193 Gr B8 CL-I SS	A (Updated 10/06/09)
N/A	A193 Gr B8 CL-I SS	B
67612	A307 Gr A/B Black	C (Updated 07/22/99)
67614	A307 Gr A/B Galv.	C (Updated 07/22/99)
67612	A307 Gr B Black	D
67614	A307 Gr B Galv.	D
65501	A325 TY-I Black	E
67616	A325 TY-I Galv.	E
65503	A325 TY-III Black	F

A	
B	
C	
D	
E	

F	
---	---

P/S No.	P/S Name	City	State	Date	Status
1594-01	Gaffney Bolt & Nut Co.	Rockford	IL	12/08/98	APPR

Mat. Code	Mat. Type	Figure
67612	A307 Gr A/B Black	A
67614	A307 Gr A/B Galv.	A
65501	A325 TY-I Black	B (Updated 06/06/00)
67616	A325 TY-I Galv.	B (Updated 06/06/00)
67617	A449 Black	C
67618	A449 Galv.	C

A	
B	
C	

P/S No.	P/S Name	City	State	Date	Status
3100-01	Huck Mfg. Co.	Waco	TX	12/08/98	APPR

Mat. Code	Mat. Type	Figure
65501	A325 TY-I Black	A
67616	A325 TY-I Galv.	A

A	
---	---

P/S No.	P/S Name	City	State	Date	Status
4440-01	Le Jeune Bolt Co.	Lakeville	MN	12/08/98	APPR

Mat. Code	Mat. Type	Figure
65501	A325 TY-I Black	A
67616	A325 TY-I Galv.	A
65503	A325 TY-III Black	B
67619	A490 TY-I Black	C

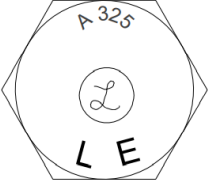
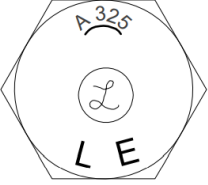
A	
B	
C	

P/S No.	P/S Name	City	State	Date	Status
2799-02	Lewis Bolt & Nut Co.	La Junta	CO	5/02/00	APPR

Mat. Code	Mat. Type	Figure
67669	A307 Gr A/B Black/Galv. Lag	A

A	
---	--

P/S No.	P/S Name	City	State	Date	Status
1244-01	Maryland Bolt & Nut Div.	Baltimore	MD	12/08/98	APPR

Mat. Code	Mat. Type	Figure
65501	A325 TY-I Black	A
67616	A325 TY-I Galv.	A
65503	A325 TY-III Black	B

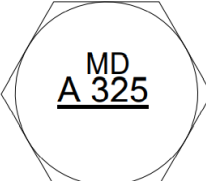
A	 <p><i>* Leonard Jed Co.</i></p>
B	 <p><i>* Leonard Jed Co.</i></p>

P/S No.	P/S Name	City	State	Date	Status
4397-01	Mid-West Fabricating Co.	Amanda	OH	12/08/98	APPR

Mat. Code	Mat. Type	Figure
67612	A307 Gr A/B Black	A
67614	A307 Gr A/B Galv.	A
67612	A307 Gr B Black	B
67614	A307 Gr B Galv.	B
67631	A307 Rnd. Head Galv.	C
65501	A325 TY-I Black	D (Updated 10/03/08)
67616	A325 TY-I Galv.	D (Updated 10/03/08)

A	
B	
C	
D	

P/S No.	P/S Name	City	State	Date	Status
4619-01	MNP Manufacturing Corp.	Utica	MI	12/08/98	APPR

Mat. Code	Mat. Type	Figure
67612	A307 Gr A/B Black	A
67614	A307 Gr A/B Galv.	A
67612	A307 Gr B Black	B
67614	A307 Gr B Galv.	B
65501	A325 TY-I Black	C
67616	A325 TY-I Galv.	C

A	
B	
C	

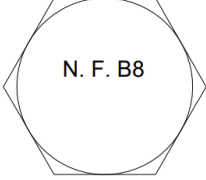
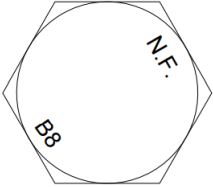

P/S No.	P/S Name	City	State	Date	Status
2865-01	Non-Ferrous Bolt & Mfg.	Las Vegas	NV	12/08/98	APPR

Mat. Code	Mat. Type	Figure
67608	A193 Gr B8 CL-I SS	A
N/A	A193 Gr B8 CL-II	B

A	
B	

P/S No.	P/S Name	City	State	Date	Status
4392-01	NSS Industries	Plymouth	MI	12/08/98	APPR

Mat. Code	Mat. Type	Figure
67612	A307 Gr A/B Black	A
67614	A307 Gr A/B Galv.	A
N/A	A325 TY-I Trq.	B

A	
B	

P/S No.	P/S Name	City	State	Date	Status
2394-05	Nucor Fasteners	St. Joe	IN	12/08/98	APPR

Mat. Code	Mat. Type	Figure
67612	A307 Gr A/B Black	A
67614	A307 Gr A/B Galv.	A
65501	A325 TY-I Black	B (Updated 05/16/08)
67616	A325 TY-I Galv.	B (Updated 05/16/08)
65503	A325 TY-III Black	C
67617	A449 Black	D
67618	A449 Galv.	D
67619	A490 TY-I Black	E
67673	A490 TY-III Black	F

A	
B	
C	
D	
E	

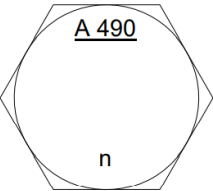
F	 <p>The diagram shows a circle with an inscribed regular hexagon. The top vertex of the hexagon is labeled "A 490" and the bottom vertex is labeled "n".</p>
---	---

P/S No.	P/S Name	City	State	Date	Status
4655-01	Portland Bolt Co.	Portland	OR	12/08/98	APPR



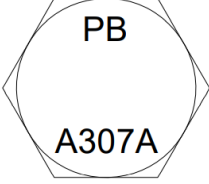
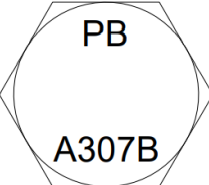
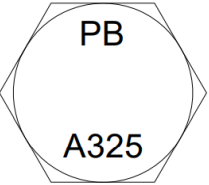
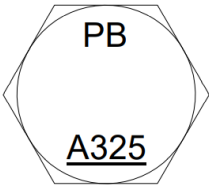
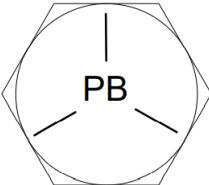

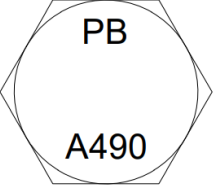
Mat. Code	Mat. Type	Figure
67612	A307 Gr A/B Black	A
67614	A307 Gr A/B Galv.	A
67612	A307 Gr B Black	B
67614	A307 Gr B Galv.	B
65501	A325 TY-I Black	C
67616	A325 TY-I Galv.	C
65503	A325 TY-III Black	D
67617	A449 Black	E
67618	A449 Galv.	E
67619	A490 TY-I Black	F

A	
B	
C	
D	
E	

F	
---	---

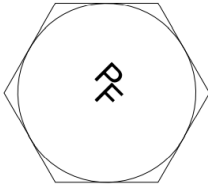
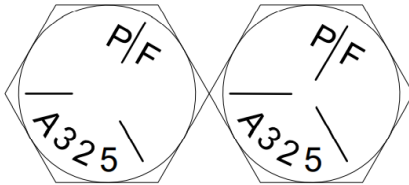
P/S No.	P/S Name	City	State	Date	Status
3886-01	ProFast Mfg. Corp.	Mokena	IL	12/08/98	APPR

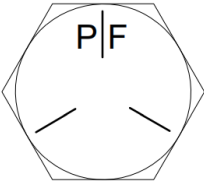
Mat. Code	Mat. Type	Figure
67612	A307 Gr A/B Black	A
67614	A307 Gr A/B Galv.	A
65501	A325 TY-I Black	B
67616	A325 TY-I Galv.	B
65503	A325 TY-III Black	C
67617	A449 Black	D
67618	A449 Galv.	D
67619	A490 TY-I Black	E

A	
B	
C	
D	
E	

P/S No.	P/S Name	City	State	Date	Status
4438-01	Robbins Mfg. Co., Inc.	Fall River	MA	12/08/98	APPR

Mat. Code	Mat. Type	Figure
67608	A193 Gr B8 CL-I SS	A
N/A	A193 Gr B8M CL-I SS	B

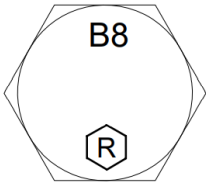
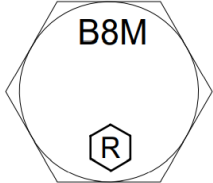
A	 <p>The diagram shows a hexagonal nut with a central hole. The text 'B8' is positioned above the hole, and a small hexagon containing the letter 'R' is positioned below the hole. The nut is shown with perspective lines to indicate its three-dimensional form.</p>
B	 <p>The diagram shows a hexagonal nut with a central hole. The text 'B8M' is positioned above the hole, and a small hexagon containing the letter 'R' is positioned below the hole. The nut is shown with perspective lines to indicate its three-dimensional form.</p>

P/S No.	P/S Name	City	State	Date	Status
4318-01	Rockford Bolt & Steel Company	Rockford	IL	12/08/98	APPR

Mat. Code	Mat. Type	Figure
67612	A307 Gr A/B Black	A
67614	A307 Gr A/B Galv.	A
67631	A307 Rnd. Head Galv.	B (Updated 04/03/00)
67612	A307 Sqr. Head Black	C
67614	A307 Sqr. Head Galv.	C
67616	A325 TY-I Black	D (Updated 08/17/00)
67616	A325 TY-I Galv.	D (Updated 08/17/00)
67617	A449 Black	E
67618	A449 Galv.	E

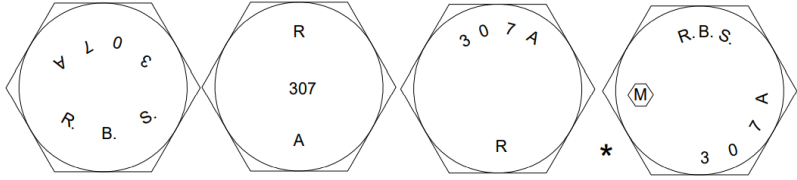
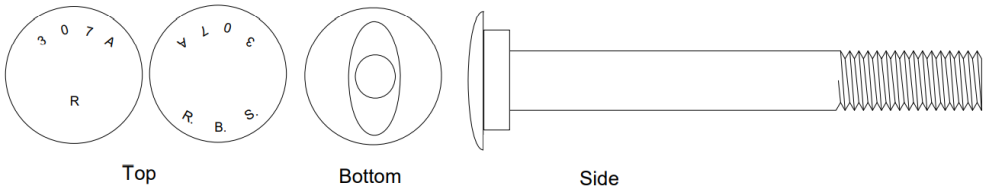
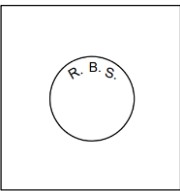
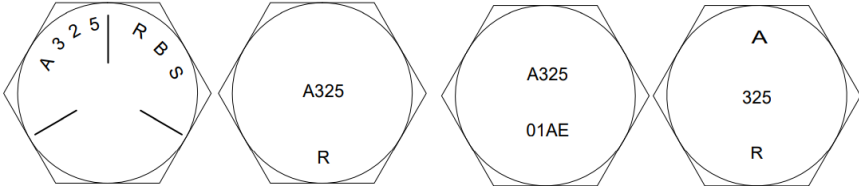
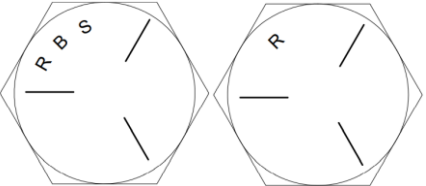
A	 <p style="text-align: center;"><i>*Produced for Rockford Bolt by MNP corp. P/S No. 4619-01</i></p>
B	 <p style="text-align: center;">Top Bottom Side</p>
C	
D	
E	

P/S No.	P/S Name	City	State	Date	Status
4612-01	Silo Fastener, Inc.	Kansas City	MO	12/08/98	APPR

Mat. Code	Mat. Type	Figure
67612	A307 Gr A/B Black	A (Updated 05/03/06)
67614	A307 Gr A/B Galv.	A (Updated 05/03/06)
67612	A307 Gr B Black	B
67614	A307 Gr B Galv.	C

A	
B	
C	

P/S No.	P/S Name	City	State	Date	Status
1810-01	Southwestern Bolt & Screw	Birmingham	AL	12/08/98	APPR



Mat. Code	Mat. Type	Figure
67612	A307 Gr A/B Black	A
67614	A307 Gr A/B Galv.	A

A	
---	--

P/S No.	P/S Name	City	State	Date	Status
1728-01	St. Louis Screw & Bolt Co.	St. Louis	MO	12/08/98	APPR

Mat. Code	Mat. Type	Figure
67612	A307 Gr A/B Black	A
67614	A307 Gr A/B Galv.	A
67612	A307 Gr B Black	B
67614	A307 Gr B Galv.	B
65501	A325 TY-I Black	C (Updated 11/23/22)
67616	A325 TY-I Galv.	C (Updated 11/23/22)
65503	A325 TY-III Black	D (Updated 11/23/22)
67617	A449 TY-I Black	E (Updated 11/23/22)
67618	A449 TY-I Galv.	E (Updated 11/23/22)
67619	A490 TY-I Black	F (Updated 11/23/22)
67619	A490 TY-III Black	G (Added 11/23/22)

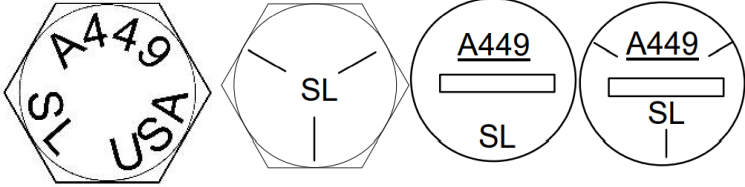
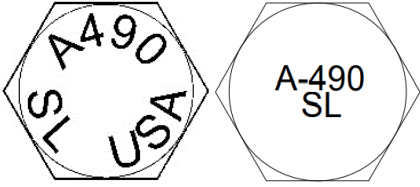
A	
B	
C	<p style="text-align: center; font-size: small;">*Produced by Fontana Fasteners (P/S No. 1100-01) for St. Louis Screw & Bolt)</p>
D	<p style="text-align: center; font-size: small;">*Produced by Fontana Fasteners (P/S No. 1100-01) for St. Louis Screw & Bolt)</p>

E	
F	
G	

P/S No.	P/S Name	City	State	Date	Status
2984-01	Standard Bolt & Nut Co.	Cumberland	RI	12/08/98	APPR

Mat. Code	Mat. Type	Figure
67608	A193 Gr B8 CL-I SS	A (<i>Updated 05/03/06</i>)
N/A	A193 Gr B8 CL-I SS STD	B

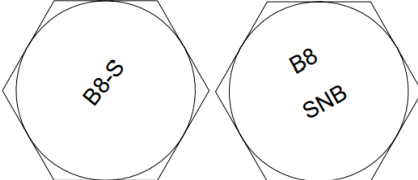
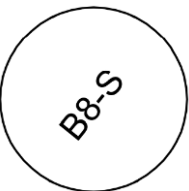
A	
B	

P/S No.	P/S Name	City	State	Date	Status
1849-01	Steel City Bolt & Screw	Birmingham	AL	12/08/98	APPR

Mat. Code	Mat. Type	Figure
67612	A307 Gr A/B Black	A
67614	A307 Gr A/B Galv.	A
65501	A325 TY-I Black	B
67616	A325 TY-I Galv.	B

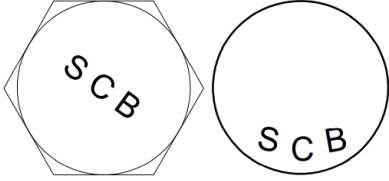
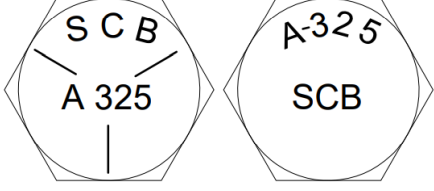
A	
B	

P/S No.	P/S Name	City	State	Date	Status
1911-01	Texas Bolt Company	Houston	TX	12/08/98	APPR

Mat. Code	Mat. Type	Figure
67608	A193 Gr B8 CL-I	A
N/A	A193 Gr B8 CL-II	B
65501	A325 TY-I Black	C
67616	A325 TY-I Galv.	C
67619	A490 TY-I Black	D

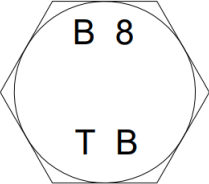
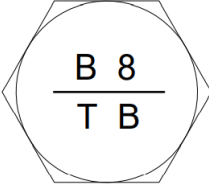
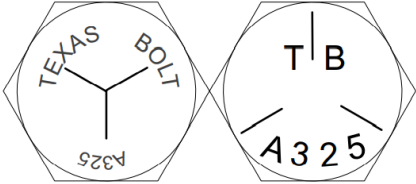
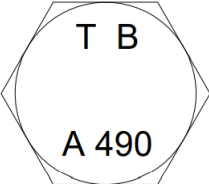
A	
B	
C	
D	

P/S No.	P/S Name	City	State	Date	Status
2214-03	Trinity Industries, Inc.	Lima	OH	12/08/98	APPR

Mat. Code	Mat. Type	Figure
67612	A307 Gr A/B Black	A (Updated 05/03/06)
67614	A307 Gr A/B Galv.	A (Updated 05/03/06)
67612	A307 Gr B Black	B
67614	A307 Gr B Galv.	B

A	
B	

P/S No.	P/S Name	City	State	Date	Status
2010-02	Unytite, Inc.	Peru	IL	12/08/98	APPR

Mat. Code	Mat. Type	Figure
65501	A325 TY-I Black	A
67616	A325 TY-I Galv.	A
65503	A325 TY-III Black	B

A	
B	

P/S No.	P/S Name	City	State	Date	Status
6075-01	Vegas Fastener Manufacturing	Las Vegas	NV	10/03/08	APPR

Mat. Code	Mat. Type	Figure
67608	A193 Gr B8 CL-I SS	A

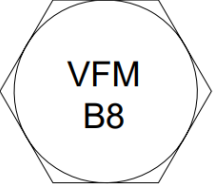
A	
---	---

P/S No.	P/S Name	City	State	Date	Status
5634-01	Vermont Fastener Manufacturing	Swanton	VT	4/09/99	APPR

Mat. Code	Mat. Type	Figure
67612	A307 Gr A/B Black	A
67614	A307 Gr A/B Galv.	A
65501	A325 TY-I Black	B
67616	A325 TY-I Galv.	B
65503	A325 TY-III Black	C
67619	A490 TY-I Black	D
67673	A490 TY-III Black	E

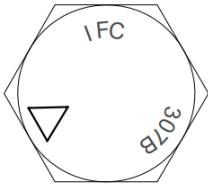
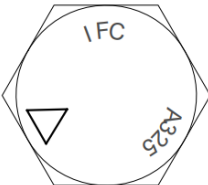
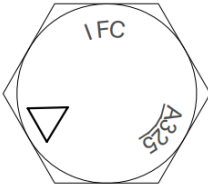
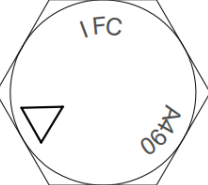
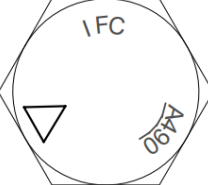
A	
B	
C	
D	
E	

*Figures A through E: Fasteners must have the "IFC" logo with the triangle to be of domestic origin.

P/S No.	P/S Name	City	State	Date	Status
2049-01	Vulcan Rivet & Bolt Comp.	Birmingham	AL	12/08/98	APPR

Mat. Code	Mat. Type	Figure
67612	A307 Gr A/B Black	A
67614	A307 Gr A/B Galv.	A
65501	A325 TY-I Black	B

A	
B	

Fasteners—Studs

P/S No.	P/S Name	City	State	Date	Status
6525-01	Cox Industries	Macomb	MI	06/XX/22	APPR

Mat. Code	Mat. Type	Figure
65801	Stud Shear Connector	A

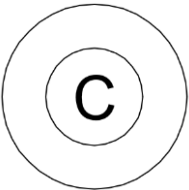
A	
---	---

P/S No.	P/S Name	City	State	Date	Status
2233-01	Erico Fastening System	Moorestown	NJ	12/08/98	APPR
2233-02	Erico Fastening System	Cleveland	OH	12/08/98	APPR

Mat. Code	Mat. Type	Figure
65801	Stud Shear Connector	A

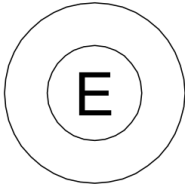
A	
---	---

P/S No.	P/S Name	City	State	Date	Status
1423-01	Nelson Stud Welding Div.	Bridgeview	IL	12/08/98	APPR
1423-02	Nelson Stud Welding Div.	Lorain	OH	12/08/98	APPR
1423-03	Nelson Stud Welding Div.	Irving	TX	12/08/98	APPR

Mat. Code	Mat. Type	Figure
65801	Stud Shear Connector	A

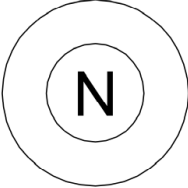
A	
---	---

P/S No.	P/S Name	City	State	Date	Status
4392-01	NSS Industries	Plymouth	MI	12/08/98	APPR

Mat. Code	Mat. Type	Figure
65801	Stud Shear Connector	A

A	
---	--

P/S No.	P/S Name	City	State	Date	Status
4273-01	Stud Welding Associates	Elyria	OH	6/09/99	APPR

Mat. Code	Mat. Type	Figure
65801	Stud Shear Connector	A

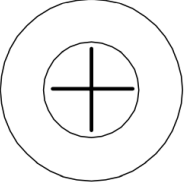
A	
---	---

P/S No.	P/S Name	City	State	Date	Status
1964-01	Tru-Fit Prods. Corp.	Medina	OH	12/08/98	APPR

Mat. Code	Mat. Type	Figure
65801	Stud Shear Connector	A

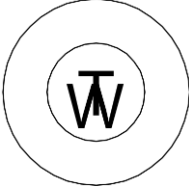
A	
---	---

Instructions for identification of nuts

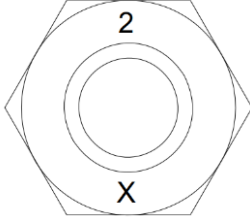
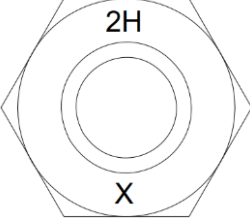
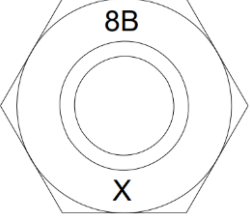
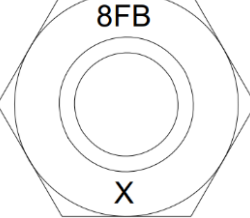
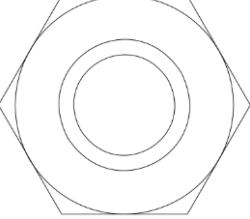
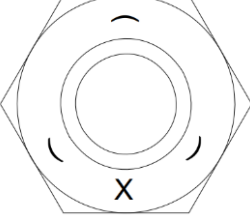
Specification and Material Codes	Grade Marking	Required Markings
ASTM A194 Grade 2 Heavy Series 65601		Symbol for identification of grade, i.e., "2". Manufacturer's identification mark, e.g., "X".
ASTM A194 Grade 2H Heavy Series 65602 Galv. 67704 Galv. Lock 67706		Symbol for identification grade, i.e., "2H" ("H" = heat-treated). Manufacturer's identification mark, e.g., "X".
ASTM A194 Grade 8 Type B Regular Series and Heavy Series		Symbol for identification of grade and type, i.e., "8B" ("B" = machined from bar stock). Manufacturer's identification mark, e.g., "X".
ASTM A194 Grade 8F Type B Regular Series and Heavy Series		Symbol for identification of grade and type, i.e., "8FB" ("B" = machined from bar stock). Manufacturer's identification mark, e.g., "X".
ASTM A563 Grade A Regular Series and Heavy Series 67728 Galv. 67729 Lock 67730 Galv. Lock 67730		No required identification marks.
ASTM A563 Grade C Heavy Series 65603 Galv.: N/A Lock: N/A Galv. Lock: N/A		Three equally spaced circumferential lines on one face. Manufacturer's identification mark, e.g., "X". Markings depressed if applied to bearing surface.

Instructions for identification of nuts

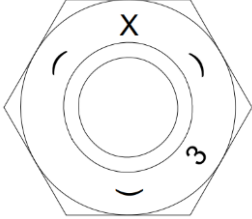
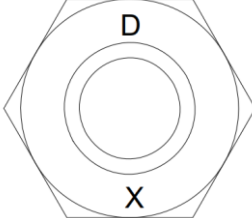
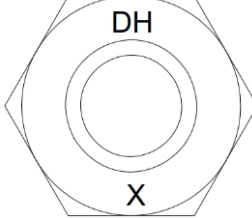
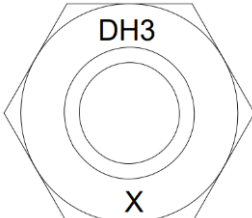
Specification and Material Codes	Grade Marking	Required Markings
<p>ASTM A563 Grade C3 Heavy Series</p> <p>Galv.: N/A Lock: N/A</p>		<p>Three equally spaced circumferential lines on one face.</p> <p>"3" on one face.</p> <p>Other distinguishing marks indicating nut is atmospheric corrosion resistant and of a weather type on one face (at option of manufacturer)</p> <p>Manufacturer's identification mark, e.g., "X".</p> <p>Markings depressed if applied to bearing surface.</p>
<p>ASTM A563 Grade D Heavy Series</p> <p>Galv. 67716 Lock 67718 Galv. Lock 67720</p>		<p>Symbol for identification of grade, i.e., "D", on one face.</p> <p>Manufacturer's identification mark, e.g., "X".</p> <p>Markings depressed if applied to bearing surface.</p>
<p>ASTM A563 Grade DH Heavy Series</p> <p>65606 Galv. 67717 Lock 67719 Galv. Lock 67721</p>		<p>Symbol for identification of grade, i.e., "DH", on one face.</p> <p>Manufacturer's identification mark, e.g., "X".</p> <p>Markings depressed if applied to bearing surface.</p>
<p>ASTM A563 Grade DH3 Heavy Series</p> <p>67734</p>		<p>Three equally spaced circumferential lines on one face.</p> <p>"3" on one face.</p> <p>Other distinguishing marks indicating nut is atmospheric corrosion resistant and of a weather type on one face (at option of manufacturer)</p> <p>Manufacturer's identification mark, e.g., "X".</p> <p>Markings depressed if applied to bearing surface.</p>

Typical: Nut Sleeve—67723

Stain. Steel—67731

Stain. Steel Lock—67732

Fasteners—Nuts

P/S No.	P/S Name	City	State	Date	Status
4505-01	A & G Engineering Co.	Anaheim	CA	12/08/98	APPR

Mat. Code	Mat. Type	Figure
65602	A194 Gr 2H Heavy Series Black	A
67704	A194 Gr 2H Heavy Series Galv.	A

A	
---	--

P/S No.	P/S Name	City	State	Date	Status
3538-01	Daniel Industries	Houston	TX	12/08/98	APPR

Mat. Code	Mat. Type	Figure
N/A	A194 Gr 2 Heavy Series Galv.	A
65602	A194 Gr 2H Heavy Series Black	A

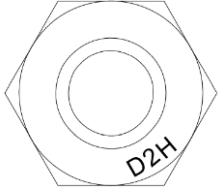
A	
---	---

P/S No.	P/S Name	City	State	Date	Status
499-01	Decker Mfg. Corp.	Albion	MI	12/08/98	APPR

Mat. Code	Mat. Type	Figure
67728	A563 Gr A Regular & Heavy Series Black	A (Updated 03/27/00)
67729	A563 Gr A Regular & Heavy Series Galv.	A (Updated 03/27/00)
65603	A563 Gr C Heavy Series Black	B
N/A	A563 Gr C Heavy Series Galv.	B
N/A	A563 Gr C3 Heavy Series Black	C
N/A	A563 Gr C3 Heavy Series Galv.	C
N/A	A563 Gr C3 Heavy Series Lock	C
65606	A563 Gr DH Heavy Series Black	D (Updated 10/03/08)
67717	A563 Gr DH Heavy Series Galv.	D (Updated 10/03/08)

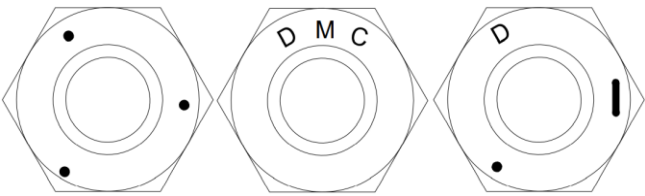
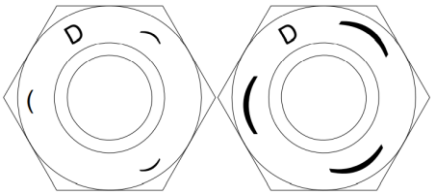
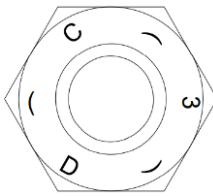
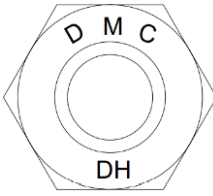
A	
B	
C	
D	

P/S No.	P/S Name	City	State	Date	Status
4686-01	Del-Val Fastener Mfg. Co., Inc.	Ivyland	PA	12/08/98	APPR

Mat. Code	Mat. Type	Figure
N/A	A194 Gr 8 Type B Regular & Heavy Series Black	A
N/A	A194 Gr 8 Type B Regular & Heavy Series Galv.	A
N/A	A194 Gr 8F Type B Regular & Heavy Series Black	B
N/A	A194 Gr 8F Type B Regular & Heavy Series Galv.	B

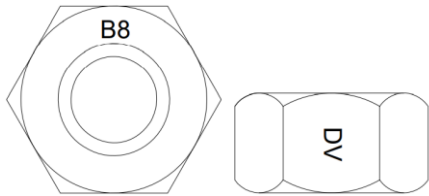
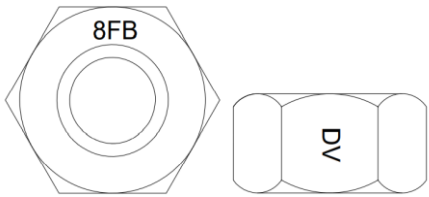
A	
B	

P/S No.	P/S Name	City	State	Date	Status
4744-01	Domestic Forging, Inc.,	New Haven	MI	10/18/01	APPR

Mat. Code	Mat. Type	Figure
65601	A194 Gr 2 Heavy Series Black	A
N/A	A194 Gr 2 Heavy Series Galv.	A
65602	A194 Gr 2H Heavy Series Black	B
67704	A194 Gr 2H Heavy Series Galv.	B
67728	A563 Gr A Regular & Heavy Series Black	C
67729	A563 Gr A Regular & Heavy Series Galv.	C
65603	A563 Gr C Heavy Series Black	A
N/A	A563 Gr C Heavy Series Galv.	A
67734	A563 Gr DH3 Heavy Series Black	D
65606	A563 Gr DH Heavy Series Black	E
67717	A563 Gr DH Heavy Series Galv.	E

A	
B	
C	
D	

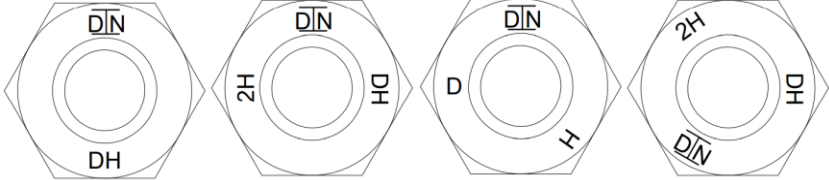
E	 <p>The image shows four technical drawings of hexagonal nuts, each with a different thread type and marking. The first nut has a standard thread with 'DIN' at the top and 'DH' at the bottom. The second nut has a 2H thread with 'DIN' at the top, '2H' on the left, and 'HD' on the right. The third nut has a D thread with 'DIN' at the top, 'D' on the left, and 'H' on the right. The fourth nut has a 2H thread with '2H' at the top, 'HD' on the right, and 'DIN' at the bottom.</p>
---	--



P/S No.	P/S Name	City	State	Date	Status
5709-01	Dyson Corp. Domestic	Painsville	OH	10/18/01	APPR

Mat. Code	Mat. Type	Figure
65601	A194 Gr 2 Heavy Series Black	A (Updated 05/16/08)
N/A	A194 Gr 2 Heavy Series Galv.	A (Updated 05/16/08)
65602	A194 Gr 2H Heavy Series Black	B (Updated 05/16/08)
67704	A194 Gr 2H Heavy Series Galv.	B (Updated 05/16/08)
67728	A563 Gr A Regular & Heavy Series Black	A (Updated 05/16/08)
67729	A563 Gr A Regular & Heavy Series Galv.	A (Updated 05/16/08)
65603	A563 Gr C Heavy Series Black	A (Updated 05/16/08)
N/A	A563 Gr C Heavy Series Galv.	A (Updated 05/16/08)
67734	A563 Gr DH3 Heavy Series Black	C
65606	A563 Gr DH Heavy Series Black	B (Updated 05/16/08)
67717	A563 Gr DH Heavy Series Galv.	B (Updated 05/16/08)

A	
B	
C	

P/S No.	P/S Name	City	State	Date	Status
1100-01	Fontana Fasteners	Frankfort	IN	12/08/98	APPR

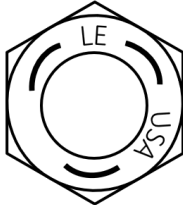
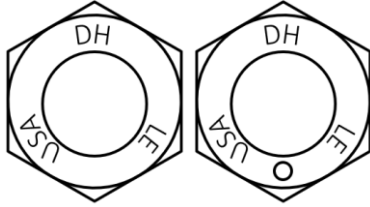
Mat. Code	Mat. Type	Figure
65602	A194 Gr 2H Heavy Series Black	A (Added 11/23/22)
67704	A194 Gr 2H Heavy Series Galv.	A (Added 11/23/22)
65603	A563 Gr C Heavy Series Black	B (Added 11/23/22)
N/A	A563 Gr C Heavy Series Galv.	B (Added 11/23/22)
65606	A563 Gr DH Heavy Series Black	C (Added 11/23/22)
67717	A563 Gr DH Heavy Series Galv.	C (Added 11/23/22)
67734	A563 Gr DH3 Heavy Series Black	D (Added 11/23/22)

A	
B	
C	 <p style="text-align: center;"><i>Dot stands for O/S inside diameter.</i></p>
D	

P/S No.	P/S Name	City	State	Date	Status
2253-01	Jacobson Mfg. Co., Inc.	Kenilworth	NJ	12/08/98	APPR

Mat. Code	Mat. Type	Figure
65601	A194 Gr 2 Heavy Series Black	A
N/A	A194 Gr 2 Heavy Series Galv.	A
65602	A194 Gr 2H Heavy Series Black	B
67704	A194 Gr 2H Heavy Series Galv.	B

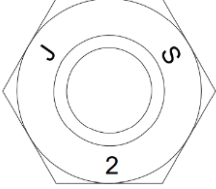
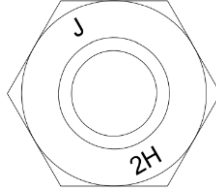
A	
B	

P/S No.	P/S Name	City	State	Date	Status
551-01	Joseph Dyson & Sons	Painesville	OH	12/08/98	APPR

Mat. Code	Mat. Type	Figure
65601	A194 Gr 2 Heavy Series Black	A
N/A	A194 Gr 2 Heavy Series Galv.	A
65602	A194 Gr 2H Heavy Series Black	B
67704	A194 Gr 2H Heavy Series Galv.	B
67728	A563 Gr A Regular & Heavy Series Black	C
67729	A563 Gr A Regular & Heavy Series Galv.	C

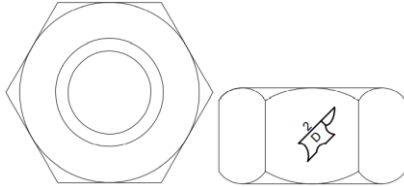
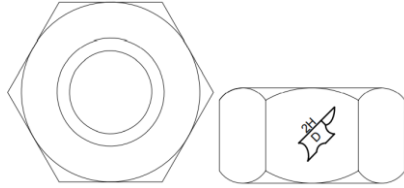
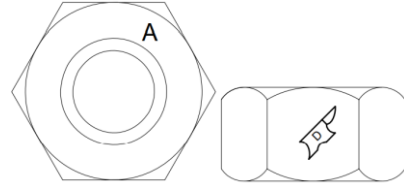
A	
B	
C	

P/S No.	P/S Name	City	State	Date	Status
4440-01	Le Jeune Bolt Co.	Lakeville	MN	10/18/01	APPR

Mat. Code	Mat. Type	Figure
65602	A194 Gr 2H Heavy Series Black	A
67704	A194 Gr 2H Heavy Series Galv.	A

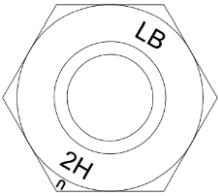
A	 <p><i>*Produced for Le Jeune Bolt by P/S# 2010-02</i></p>
---	---

P/S No.	P/S Name	City	State	Date	Status
2724-02	Metform, Inc.	Savanna	IL	12/08/98	APPR

Mat. Code	Mat. Type	Figure
65602	A194 Gr 2H Heavy Series Black	A
67706	A194 Gr 2H Heavy Series Lock Galv.	A
65603	A563 Gr C Heavy Series Black	B
N/A	A563 Gr C Heavy Series Galv.	B
N/A	A563 Gr C3 Heavy Series Galv.	C
65606	A563 Gr DH Heavy Series Black	D
67717	A563 Gr DH Heavy Series Galv.	D

A	
B	
C	
D	

**Figures A through D: On opposite side of the bolt.*

P/S No.	P/S Name	City	State	Date	Status
4392-01	NSS Industries	Plymouth	MI	12/08/98	APPR

Mat. Code	Mat. Type	Figure
65602	A194 Gr 2H Heavy Series Black	A
67704	A194 Gr 2H Heavy Series Galv.	A
65606	A563 Gr DH Heavy Series Black	B
67717	A563 Gr DH Heavy Series Galv.	B

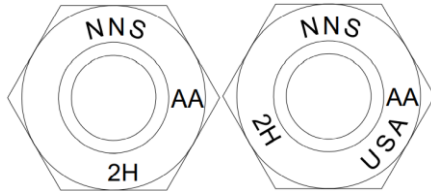
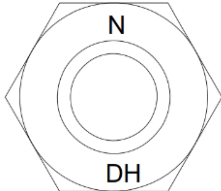
A	
B	

P/S No.	P/S Name	City	State	Date	Status
2394-05	Nucor Fasteners	St. Joe	IN	12/08/98	APPR

Mat. Code	Mat. Type	Figure
65602	A194 Gr 2H Heavy Series Black	A
67704	A194 Gr 2H Heavy Series Galv.	A
65609	A563 Gr A Regular & Heavy Series Black Rec.	B (Updated 10/18/01)
65610	A563 Gr A Regular & Heavy Series Galv. Rec.	B (Updated 10/18/01)
65603	A563 Gr C Heavy Series Black	C
N/A	A563 Gr C Heavy Series Galv.	C
N/A	A563 Gr C3 Heavy Series Black	D
N/A	A563 Gr C3 Heavy Series Galv.	D
65606	A563 Gr DH Heavy Series Black	E
67717	A563 Gr DH Heavy Series Galv.	E
67734	A563 Gr DH3 Heavy Series Black	F

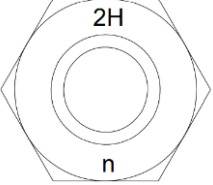
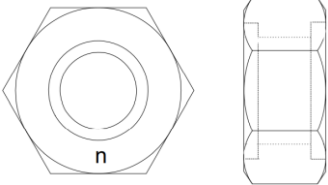
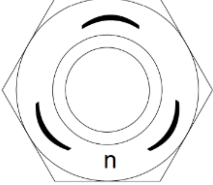
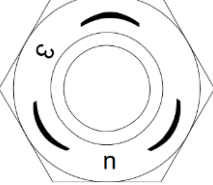
A	
B	
C	
D	

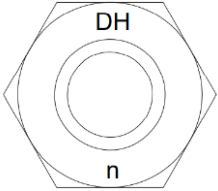
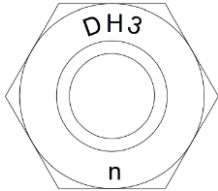
E	 <p>A technical drawing of a hexagonal nut. It features a central circular hole surrounded by a chamfered inner edge. The outer edge is a regular hexagon. The label 'DH' is positioned at the top, and 'n' is at the bottom.</p>
F	 <p>A technical drawing of a hexagonal nut, similar to the one above. It features a central circular hole surrounded by a chamfered inner edge. The outer edge is a regular hexagon. The label 'DH3' is positioned at the top, and 'n' is at the bottom.</p>

P/S No.	P/S Name	City	State	Date	Status
1715-02	RB & W Corp.	Caraopolis	PA	12/08/98	APPR

Mat. Code	Mat. Type	Figure
67728	A563 Gr A Regular & Heavy Series Black	A
67729	A563 Gr A Regular & Heavy Series Galv.	A
65603	A563 Gr C Heavy Series Black	B
N/A	A563 Gr C Heavy Series Galv.	B

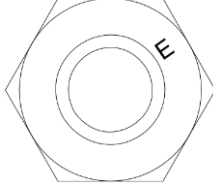
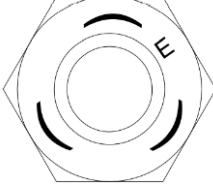
A	
B	

P/S No.	P/S Name	City	State	Date	Status
4438-01	Robbins Mfg. Co., Inc.	Fall River	MA	4/10/00	APPR

Mat. Code	Mat. Type	Figure
67731	A194 Gr 8 Stainless Steel	A

A	
---	--

P/S No.	P/S Name	City	State	Date	Status
4027-01	Sheffield, Inc.	Kansas	MO	12/08/98	APPR

Mat. Code	Mat. Type	Figure
65603	A563 Gr C Heavy Series Black	A
N/A	A563 Gr C Heavy Series Galv.	A
N/A	A563 Gr C3 Heavy Series Black	B
N/A	A563 Gr C3 Heavy Series Galv.	B

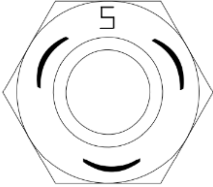
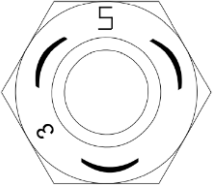
A	
B	

P/S No.	P/S Name	City	State	Date	Status
2984-01	Standard Bolt & Nut Co.	Cumberland	RI	12/08/98	APPR

Mat. Code	Mat. Type	Figure
N/A	A194 Gr 8 Heavy Series Black	A
N/A	A194 Gr 8 Heavy Series Galv.	A

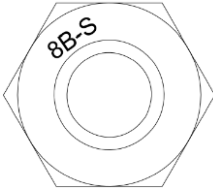
A	
---	---

P/S No.	P/S Name	City	State	Date	Status
4493-01	Telefast Industries, Inc.	Berea	OH	12/08/98	APPR

Mat. Code	Mat. Type	Figure
65602	A194 Gr 2H Heavy Series Black	A
67704	A194 Gr 2H Heavy Series Galv.	A
67728	A563 Gr A Regular & Heavy Series Black	B
67729	A563 Gr A Regular & Heavy Series Galv.	B
65603	A563 Gr C Heavy Series Black	C
N/A	A563 Gr C Heavy Series Galv.	C
N/A	A563 Gr C3 Heavy Series Black	D
N/A	A563 Gr C3 Heavy Series Galv.	D
65606	A563 Gr DH Heavy Series Black	E
67717	A563 Gr DH Heavy Series Galv.	E

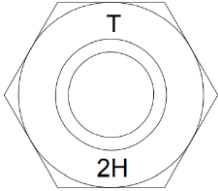
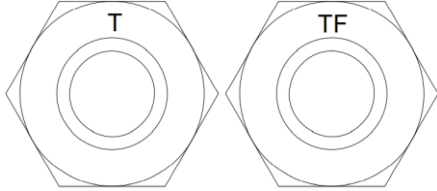
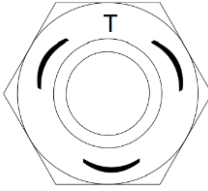
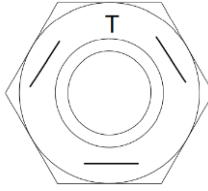
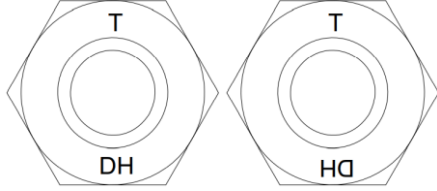
A	
B	
C	
D	
E	

P/S No.	P/S Name	City	State	Date	Status
1911-01	Texas Bolt Company	Houston	TX	12/08/98	APPR

Mat. Code	Mat. Type	Figure
65601	A194 Gr 2 Heavy Series Black	A
N/A	A194 Gr 2 Heavy Series Galv.	A
65602	A194 Gr 2H Heavy Series Black	B
67704	A194 Gr 2H Heavy Series Galv.	B
N/A	A194 Gr 2H Heavy Series Lock Black	C
67706	A194 Gr 2H Heavy Series Lock Galv.	C
N/A	A194 Gr 8 Regular & Heavy Series Black	D
N/A	A194 Gr 8 Regular & Heavy Series Galv.	D
67731	A194 Gr 8 Stainless Steel	E
67728	A563 Gr A Regular & Heavy Series Black	F
67729	A563 Gr A Regular & Heavy Series Galv.	F
65606	A563 Gr DH Heavy Series Black	G (updated 10/05/99)
67717	A563 Gr DH Heavy Series Galv.	G (updated 10/05/99)

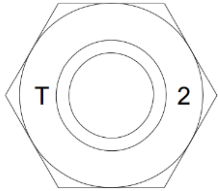
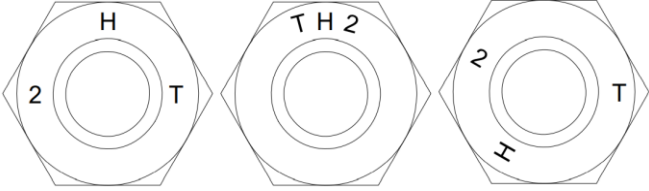
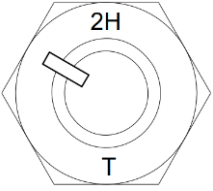
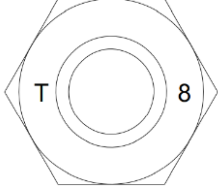
A	
B	
C	
D	

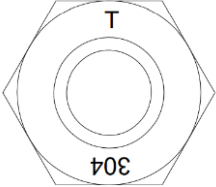
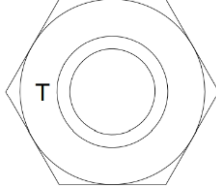
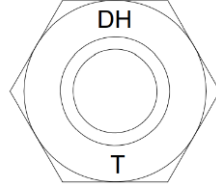
E	
F	
G	

P/S No.	P/S Name	City	State	Date	Status
2214-03	Trinity Industries, Inc.	Lima	OH	10/18/01	APPR

Mat. Code	Mat. Type	Figure
65609	A563 Gr A Regular & Heavy Series Black Rec.	A
65610	A563 Gr A Regular & Heavy Series Galv. Rec.	A

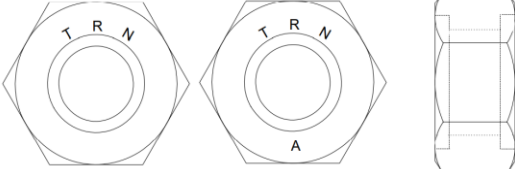
A	 <p><i>*Nut may have letters "A through F" for in house tracking</i></p>
---	--

P/S No.	P/S Name	City	State	Date	Status
4280-01	Tru-Vel Industries	Wellsville	OH	12/08/98	APPR

Mat. Code	Mat. Type	Figure
65603	A563 Gr C Heavy Series Black	A
N/A	A563 Gr C Heavy Series Galv.	A
N/A	A563 Gr C3 Heavy Series Black	B
N/A	A563 Gr C3 Heavy Series Galv.	B
65606	A563 Gr DH Heavy Series Black	C
67717	A563 Gr DH Heavy Series Galv.	C
67734	A563 Gr DH3 Heavy Series Black	D

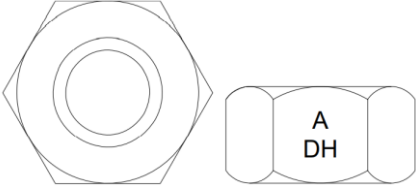
A	
B	
C	
D	

P/S No.	P/S Name	City	State	Date	Status
2010-02	Unytite, Inc.	Peru	IL	12/08/98	APPR

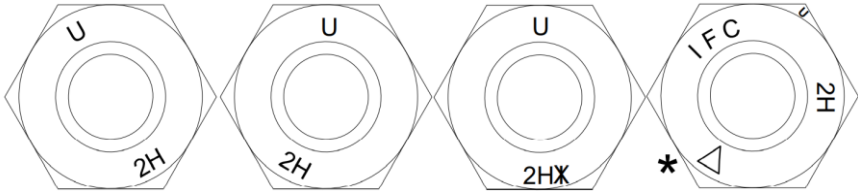
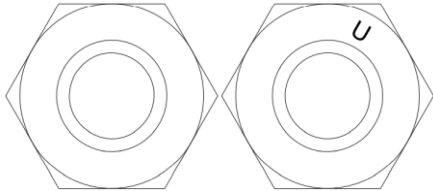
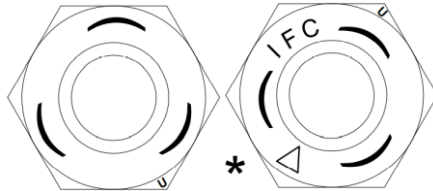
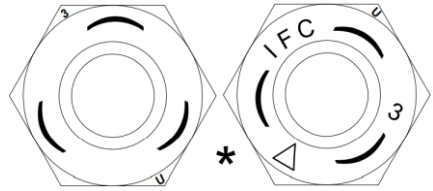

Mat. Code	Mat. Type	Figure
65602	A194 Gr 2H Heavy Series Black	A (Updated 06/06/00)
67704	A194 Gr 2H Heavy Series Galv.	A (Updated 06/06/00)
67728	A563 Gr A Regular & Heavy Series Black	B
67729	A563 Gr A Regular & Heavy Series Galv.	B
65603	A563 Gr C Heavy Series Black	C (Updated 06/06/00)
N/A	A563 Gr C Heavy Series Galv.	C (Updated 06/06/00)
N/A	A563 Gr C3 Heavy Series Black	D (Updated 06/06/00)
N/A	A563 Gr C3 Heavy Series Galv.	D (Updated 06/06/00)
N/A	A563 Gr D Heavy Series Black	E
67716	A563 Gr D Heavy Series Galv.	E
65606	A563 Gr DH Heavy Series Black	F (Updated 10/18/01)
67717	A563 Gr DH Heavy Series Galv.	F (Updated 10/18/01)
67719	A563 Gr DH Heavy Series Lock Black	G (Updated 10/11/00)
67721	A563 Gr DH Heavy Series Lock Galv.	G (Updated 10/11/00)
67735	A563 Gr DH3 Heavy Series Lock	H (Updated 10/11/00)
67734	A563 Gr DH3 Heavy Series Black	I (Updated 06/06/00)

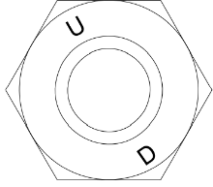
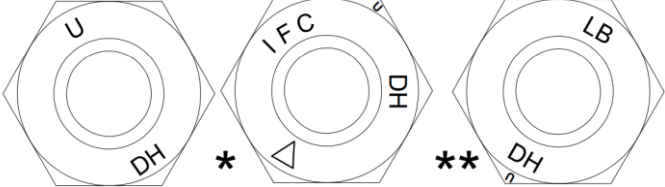
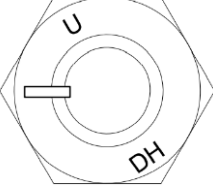
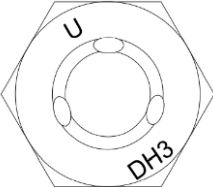
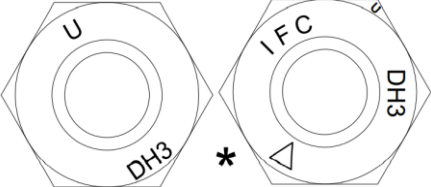
A	 <p><i>*Is produced for Vermont Fasteners P/S# 5634-01</i></p>
B	 <p><i>*No identification mark required</i></p>
C	 <p><i>*Is produced for Vermont Fasteners P/S# 5634-01</i></p>
D	 <p><i>*Is produced for Vermont Fasteners P/S# 5634-01</i></p>

E	
F	 <p data-bbox="597 617 1138 680"> <i>* Is produced for Vermont Fasteners P/S# 5634-01</i> <i>** Produced for Le Jeune Bolt P/S# 4440-01</i> </p>
G	
H	 <p data-bbox="639 1106 1089 1142"> <i>*Locking dimples in the outer most thread</i> </p>
I	 <p data-bbox="597 1337 1133 1369"> <i>*Is produced for Vermont Fasteners P/S# 5634-01</i> </p>

P/S No.	P/S Name	City	State	Date	Status
5634-01	Vermont Fastener Manufacturing	Swanton	VT	6/06/00	APPR

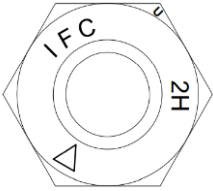
Mat. Code	Mat. Type	Figure
65602	A194 Gr 2H Heavy Series Black	A
67704	A194 Gr 2H Heavy Series Galv.	A
65603	A563 Gr C Heavy Series Black	B
N/A	A563 Gr C Heavy Series Galv.	B
N/A	A563 Gr C3 Heavy Series Black	C
N/A	A563 Gr C3 Heavy Series Galv.	C
67734	A563 Gr DH3 Heavy Series Black	D
65606	A563 Gr DH Heavy Series Black	E
67717	A563 Gr DH Heavy Series Galv.	E

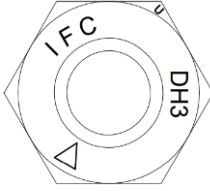
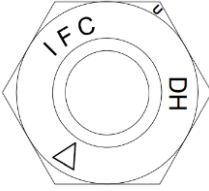
A	
B	
C	
D	
E	

**Figures A through E: Produced by Unytite P/S# 2010-02. "IFC" needed for domestic origin.*

P/S No.	P/S Name	City	State	Date	Status
2049-01	Vulcan Rivet & Bolt Corp.	Birmingham	AL	12/08/98	APPR

Mat. Code	Mat. Type	Figure
65602	A194 Gr 2H Heavy Series Black	A
67704	A194 Gr 2H Heavy Series Galv.	A
67728	A563 Gr A Regular & Heavy Series Black	B
67729	A563 Gr A Regular & Heavy Series Galv.	B

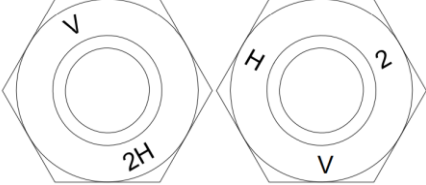
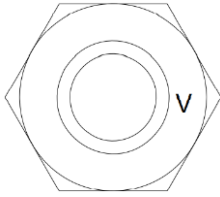
A	
B	

Instructions for identification of washers

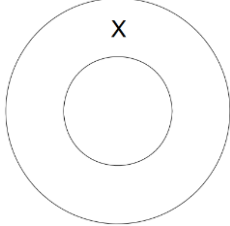
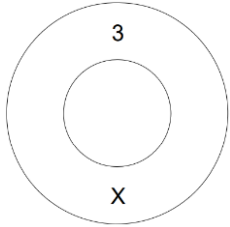
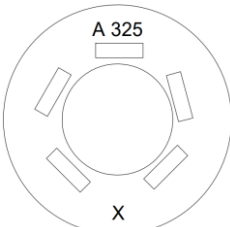
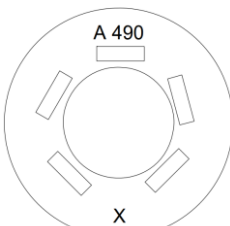
Specification and Material Codes	Grade Marking	Require Markings
ASTM F436 65701 Galv. 67801		Manufacturer's identification mark, e.g., "X". Other distinguishing marks at option of manufacturer. Markings depressed on one face.
ASTM F436 Grade 3 65702 Galv.: N/A		Manufacturer's identification mark, e.g., "X". Symbol for identification of type, i.e., "3". Other distinguishing marks at option of manufacturer. Markings depressed on one face.
ASTM F959 Type 325 67819 Galv. 67820		Manufacturer's identification mark, e.g., "X". Symbol for identification of type, i.e., "A 325". Markings depressed on the same face as the protrusions.
ASTM F959 Type 490 67821 Galv.: N/A		Manufacturer's identification mark, e.g., "X". Symbol for identification of type, i.e., "A 490". Markings depressed on the same face as the protrusions.

Typical:

Aluminum—N/A
O.G.—N/A
O.G. Galv.—N/A
Square Galv.—67815
Beveled—67808
Beveled Galv.—67809
Beveled Stainless Steel—N/A

Flat Carbon Steel—67802
Flat Galv. Carbon Steel—67804
Flat Cad. Plated Carbon Steel—N/A
Flat Stainless Steel—67806
Lock Carbon Steel—67803
Lock Galv. Carbon Steel—67805
Lock Cad. Plated Carbon Steel—N/A
Lock Stainless Steel—67807

Fasteners—Washers

P/S No.	P/S Name	City	State	Date	Status
5164-01	Alpha Stamping Co.	Livonia	MI	12/08/98	APPR

Mat. Code	Mat. Type	Figure
65701	F436 CS Black	A
67801	F436 CS Galv.	A
65702	F436 TY-III WS Black	B
N/A	F436 TY-III WS Galv.	B

A	
B	

P/S No.	P/S Name	City	State	Date	Status
5753-01	Andre Corporation	Elkhart	IN	5/16/08	APPR

Mat. Code	Mat. Type	Figure
65701	F436 CS Black	A
67801	F436 CS Galv.	A

A	
---	--

P/S No.	P/S Name	City	State	Date	Status
5360-01	Applied Bolting Technology	Ludlow	VT	10/18/01	APPR

Mat. Code	Mat. Type	Figure
67819/67820	F959 DTI A325/490 Black/Galv.	A
67821	F959 DTI A490 Black	A

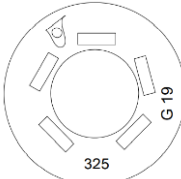
A	 <p><i>*In the case of ASTM A490, 490 will replace the 325.</i></p>
---	--

P/S No.	P/S Name	City	State	Date	Status
4252-01	Applied Press Technologies	Elwood City	PA	12/08/98	APPR

Mat. Code	Mat. Type	Figure
65701	F436 CS Black	A
67801	F436 CS Galv.	A

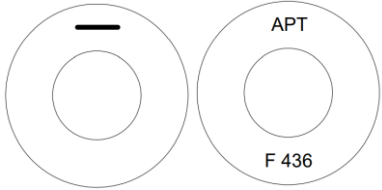
A	
---	--

P/S No.	P/S Name	City	State	Date	Status
4351-01	Beth-Fast Mfg.	Plymouth	MN	12/08/98	APPR

Mat. Code	Mat. Type	Figure
67819/67820	F959 DTI A325/490 Black/Galv.	A
67821	F959 DTI A490 Black	A

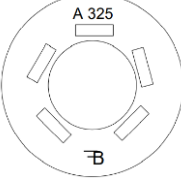
A	 <p><i>*In the case of ASTM A490, 490 will replace the 325.</i></p>
---	--

P/S No.	P/S Name	City	State	Date	Status
216-01	Binder Metal Products	Gardena	CA	12/08/98	APPR

Mat. Code	Mat. Type	Figure
65701	F436 CS Black	A
67801	F436 CS Galv.	A
65702	F436 TY-III WS Black	B (Updated 06/07/99)
N/A	F436 TY-III WS Galv.	B (Updated 06/07/99)

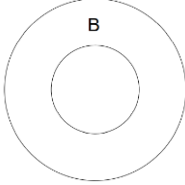
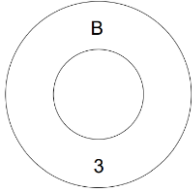
A	
B	

P/S No.	P/S Name	City	State	Date	Status
4688-01	Graham Stamping	Wheatland	PA	12/08/98	APPR

Mat. Code	Mat. Type	Figure
65701	F436 CS Black	A
67801	F436 CS Galv.	A
65702	F436 TY-III WS Black	B
N/A	F436 TY-III WS Galv.	B

A	
B	

P/S No.	P/S Name	City	State	Date	Status
1100-01	Fontana Fasteners	Frankfort	IN	12/08/98	APPR

Mat. Code	Mat. Type	Figure
65701	F436 CS Black	A <i>(Added 11/23/22)</i>
67801	F436 CS Galv.	A <i>(Added 11/23/22)</i>

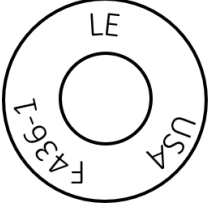
A	
---	---

P/S No.	P/S Name	City	State	Date	Status
4344-01	J & M Turner	Southampton	PA	12/08/98	APPR

Mat. Code	Mat. Type	Figure
67819/67820	F959 DTI A325/490 Black/Galv.	A
67821	F959 DTI A490 Black	A

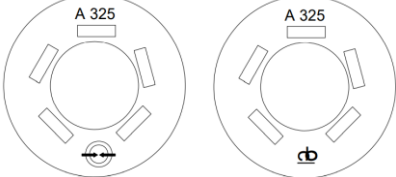
A	 <p><i>*In the case of ASTM A490, 490 will replace the 325.</i></p>
---	---

P/S No.	P/S Name	City	State	Date	Status
4555-01	J.L.K. Industries	Houston	TX	12/08/98	APPR

Mat. Code	Mat. Type	Figure
65701	F436 CS Black	A
67801	F436 CS Galv.	A
67806	Stainless Steel	B

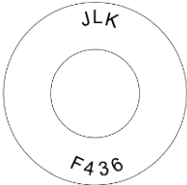
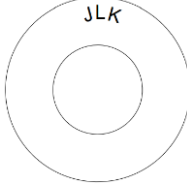
A	
B	 <p><i>*Marked only on request.</i></p>

P/S No.	P/S Name	City	State	Date	Status
4619-01	MNP Manufacturing	Utica	MI	5/03/06	APPR

Mat. Code	Mat. Type	Figure
65701	F436 CS Black	A
67801	F436 CS Galv.	A

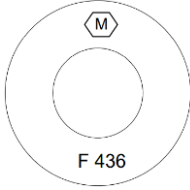
A	
---	---

P/S No.	P/S Name	City	State	Date	Status
3279-01	Prestige Stamping	Warren	MI	6/07/99	APPR

Mat. Code	Mat. Type	Figure
65701	F436 CS Black	A
67801	F436 CS Galv.	A
65702	F436 TY-III WS Black	B <i>(Updated 10/03/08)</i>

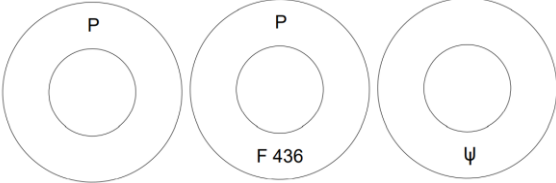
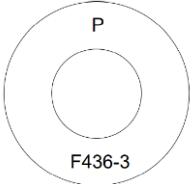
A	
B	

P/S No.	P/S Name	City	State	Date	Status
5165-01	Technical Stamping	Mt. Clemens	MI	12/08/98	APPR

Mat. Code	Mat. Type	Figure
65701	F436 CS Black	A
67801	F436 CS Galv.	A
65702	F436 TY-III WS Black	B <i>(Updated 05/23/08)</i>

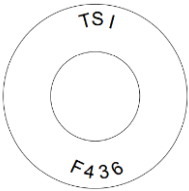
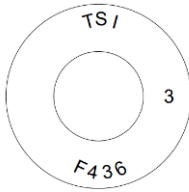
A	
B	

P/S No.	P/S Name	City	State	Date	Status
5784-01	Turnasure LLC	Brooklyn Par	MN	10/18/01	APPR

Mat. Code	Mat. Type	Figure
67819/67820	F959 DTI A325/490 Black/Galv.	A
67821	F959 DTI A490 Black	A

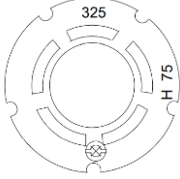
A	 <p><i>*In the case of ASTM A490, 490 will replace the 325.</i></p>
---	--

P/S No.	P/S Name	City	State	Date	Status
4611-01	Washers, Inc.	Livonia	MI	12/08/98	APPR

Mat. Code	Mat. Type	Figure
65701	F436 CS Black	A
67801	F436 CS Galv.	A
65702	F436 TY-III WS Black	B
N/A	F436 TY-III WS Galv.	B

A	
B	

P/S No.	P/S Name	City	State	Date	Status
2172-01	Wrought Washer Mfg. Co.	Milwaukee	WI	12/08/98	APPR

Mat. Code	Mat. Type	Figure
67808	F436 Beveled Black	A
67809	F436 Beveled Galv.	A
65701	F436 CS Black	B
67801	F436 CS Galv.	B
65702	F436 TY-III WS Black	C
N/A	F436 TY-III WS Galv.	C

A	
B	
C	